

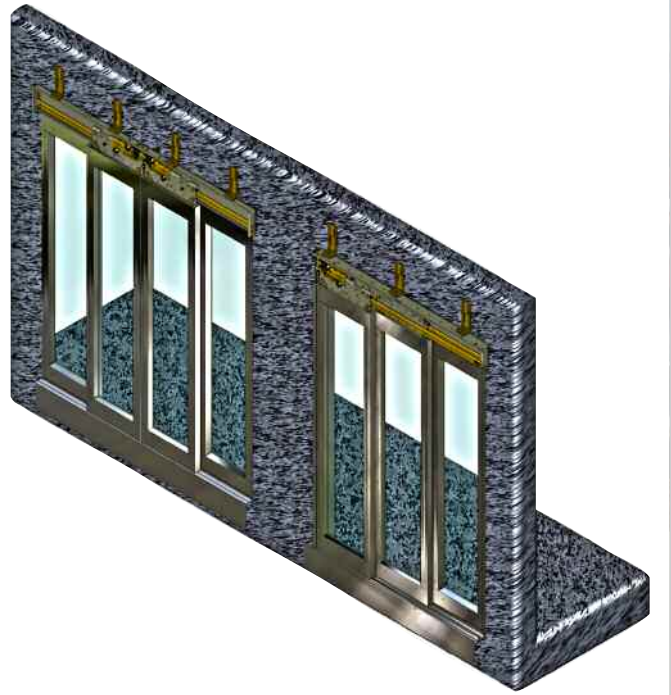

LİDYA

ASANSÖR OTOMATİK KAT KAPISI AUTOMATIC LANDING DOORS FOR ELEVATORS



UYGAR[®]
Elevator & Escalator

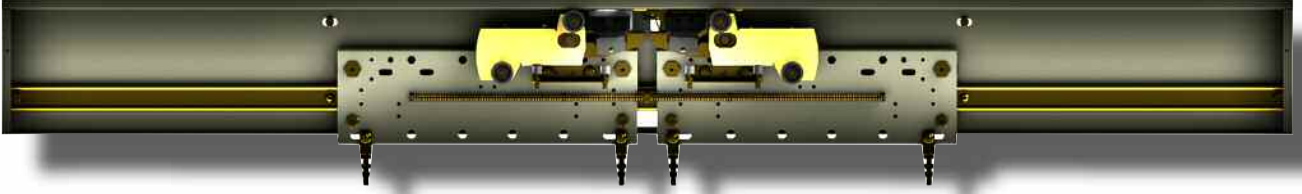

C2

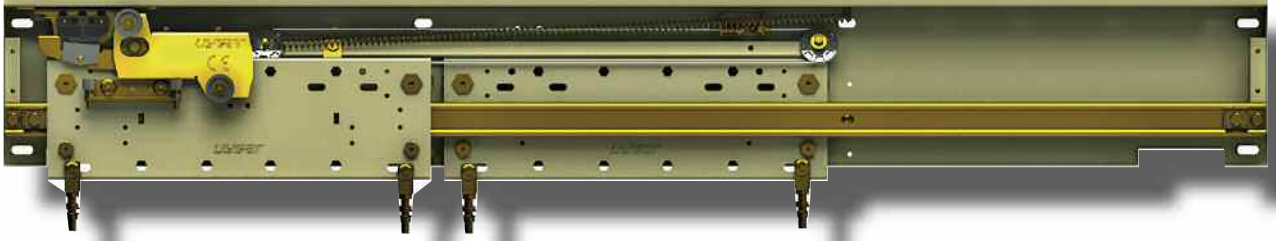

T2L

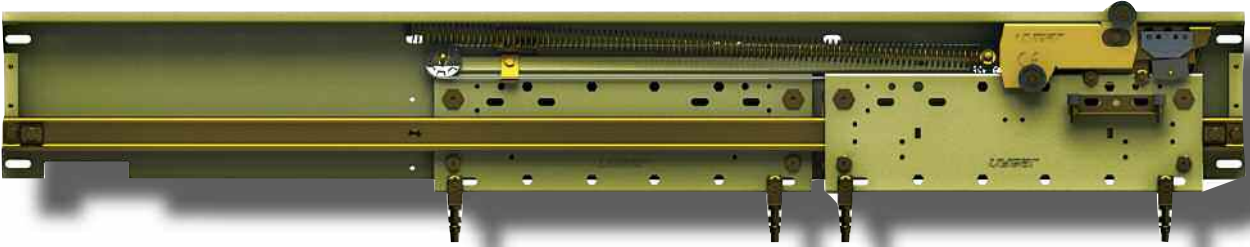

T2R

Genel avantajlar

Yüksek performans
Güvenli kullanım
Kolay kurulum
Minumum bakım

Main advantages

High performance
Operation reliability
Easy installation
Minimal maintenance

Uygulama mesafeleri / Application range

Açılış Şekli / Opening	Eşik Kalınlığı / Sill Width	Net Açılır Genişlik / CO	
T2R/L	90 mm.	Min. 600 - Max. 1600	Min. 2000 - Max. 5500
C2	54 mm.	Min. 600 - Max. 2000	
C4	90 mm.	Min. 600 - Max. 4000	

* For different dimensions consult our technical department.

* Farklı ölçüler için teknik departmanımızla iletişime geçin.

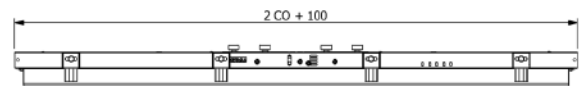
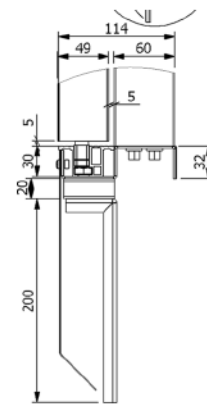
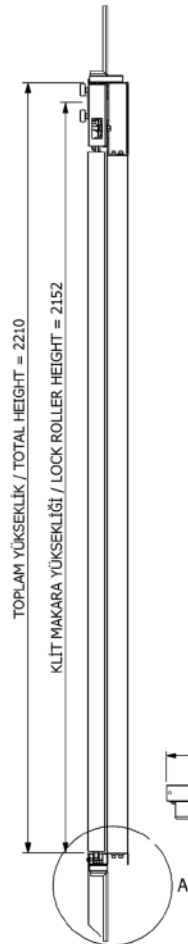
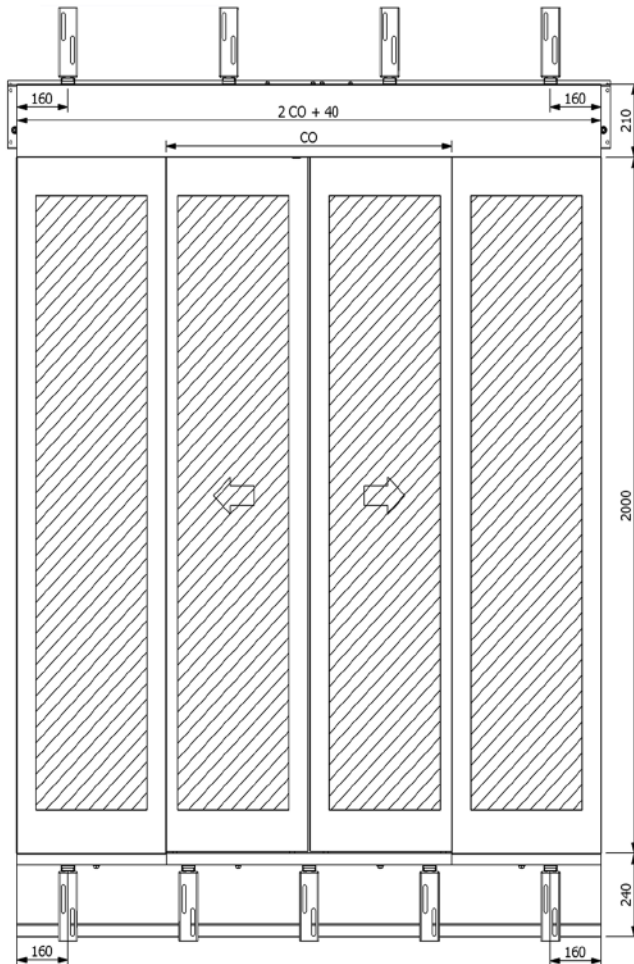
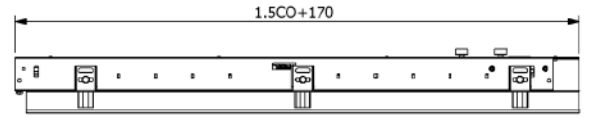
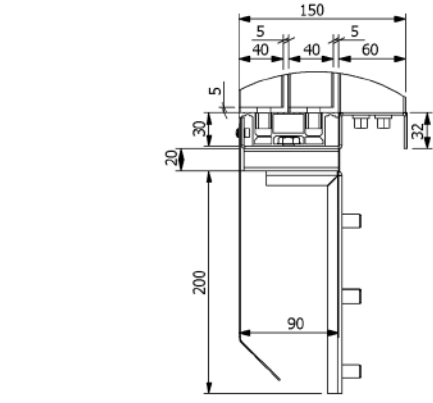
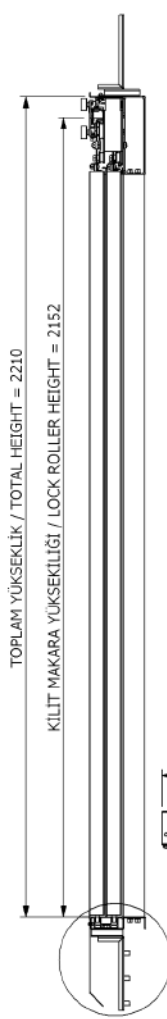
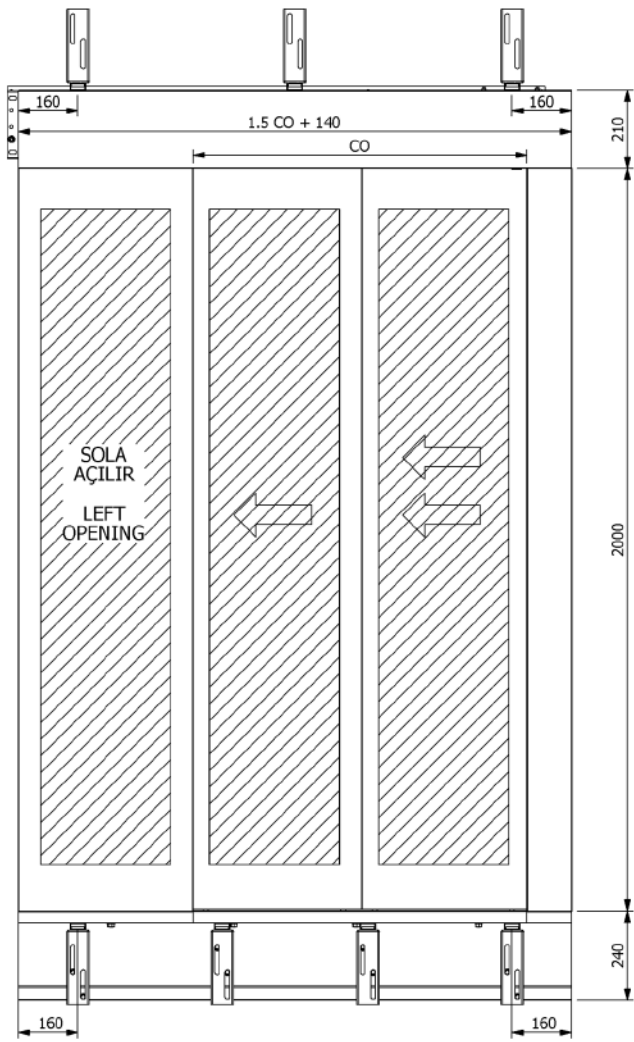



ÇIKINTISIZ CAM ÇERÇEVELİ PANELLER

- 4+4+0,76 Lamine cam
- Cam çıkıntısız panel montajı
- Arka kapaklar ile kolay cam değişimi
- Reflekte Cam (İsteğe bağlı)

ASCENT FRAME GLASS PANELS

- Laminated glass 4 +4 +0.76
- Glass flush panel mounting
- Rear doors for easy glass replacement
- Reflective Glass (Optional)

Kaplamalar / Finishes

Fırça
Desen
Paslanmaz



Brushed
stainless
steel

SB
Desen
Paslanmaz



SB
stainless
steel

Kare
Desen
Paslanmaz

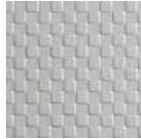

Karo
stainless
steel

Keten
Desen
Paslanmaz



Linen
stainless
steel

Deri
Desen
Paslanmaz



Leather
stainless
steel

Altın
Desen
Paslanmaz



Gold
stainless
steel

Ayna
Desen
Paslanmaz



Mirror
stainless
steel

UYGAR[®]
Elevator & Escalator



KOSGEB
www.kosgeb.gov.tr

Uygar Asansör San. ve Tic. Ltd. Şti.

1201.Sokak. No: 37 06374

Ostim / ANKARA / TÜRKİYE

Tel :+90 (312) 385 39 57 - 58 (PBX)

Mobile :+90 (530) 975 71 98 - 99

Fax:+90 (312) 354 68 83

e-mail :info@uygar.com.tr